

Sphinx

Ruggedized AI camera with 5G connectivity and real-time analytics

Introduction

Sphinx is a self-contained, ruggedized AI camera supercharged with NVIDIA Jetson Orin™ NX and Xavier™ NX system-on-modules. With dual image sensors providing excellent low-light performance, the camera offers a reliable solution for deploying various AI applications, including automatic number plate recognition (ANPR), public safety, and intelligent traffic management system (ITMS). Sphinx has Gigabit Ethernet and 5G connectivity, ensuring seamless operations even in contested environments.

Key Features

- Self-contained, ruggedized AI camera supercharged with NVIDIA Jetson Orin™ NX and Xavier™ NX system-on-modules.
- IP65 rated, it is resistant to dust and rain(water).
- Dual image sensors:
 - 5 MP (30 FPS) Fixed focus, wide field of view
 - 2.3 MP (100 FPS) with optical zoom
- A 100 FPS, 3 to 13.5mm motorized varifocal lens enables efficient recognition for fast-moving vehicles, capturing license plates from 20 meters across multiple lanes.
- The camera's built-in IR illumination enables it to operate in low-light conditions.
- Sphinx features built-in intuitive software that enables operators to configure and optimize image sensor performance in real-time.
- 128GB Industrial NVMe storage, expandable up to 1TB.
- 3-axis mounting bracket.



Specification

NVIDIA Jetson platform	Xavier NX 16GB / 8GB	CPU	. 6-core NVIDIA Carmel ARM®v8.2 64-bit CPU 6MB L2 + 4MB L3
		GPU	. 384-core NVIDIA Volta™ GPU with 48 Tensor Cores
		Memory	. 16 GB / 8 GB 128-bit LPDDR4x @ 59.7GB/s
		Storage	. 16 GB eMMC 5.1
	Orin NX 16GB / 8GB	CPU	. Orin NX 16G: 8-core Arm® Cortex®-A78AE v8.2 64-bit CPU 2MB L2 + 4MB L3 . Orin NX 8G: 6-core Arm® Cortex®-A78AE v8.2 64-bit CPU 1.5MB L2 + 4MB L3
		GPU	. 1024-core NVIDIA Ampere architecture GPU with 32 Tensor Cores
		Memory	. 16 GB / 8 GB 128-bit LPDDR5 102.4GB/s
		Storage	NVMe
General	BSP	Jetpack 5.1.1	
	Storage	128GB NVMe, extreme temperatures ranging from -40°C to 85°C.	
	Power Input	9V-16V DC input through M12 connector	
	Serial port	1x RS232 through M12 connector	
	Certification	CE, FCC, RoHS, REACH	
Network	WiFi	Optional, support Intel® Wireless-AC 9260 Wifi module	
	5G / GPS	Optional, support Quectel RM502Q-AE 5G module (PTCRB certified)	
	4G / GPS	Optional, support Quectel EM06ELA-512-SGAS 4G module	
	SIM Card slot	Nano SIM slot (at the edge IO)	
	Ethernet	1x GBE LAN through M12 connector	
	SMA connector	6x SMA connectors	
Illuminator	IR LED	4 high power LEDs, InfraRed @ 850 nm (10 meters distance)	
Environment	Operating Temp.	-20°C ~ +50°C	
	Storage Temp.	-40°C ~ +85°C	
	Storage Humidity	95% @ 40°C (non-condensing)	
	IP protection	IP65	
	Condensation Resistance	System with anti-fog design and hydrophobic glass	
	Installation	Camera bracket	
Mechanical	Dimension	275 × 163 × 94.9 mm (L x W x H) (without antenna)	
	Weight	3.8kg	
	Installation	Wall Mount (Maximum height of camera installation is 10 meters)	
Peripheral	UPS	Optional	
	LiDAR	Optional	
	Weather Sensor	Optional	
Operation System	DeepStream-app /SDK version	v.6.2.0	
	CUDA Driver / Runtime Version	v.11.4	
	TensorRT Version	v.8.5	
	cuDNN Version	v.8.6	
	libNVWarp360 Version	v.2.0.1d3	

Camera

Specification		AR0234 (Global shutter)	IMX335 (Rolling shutter)
Image Sensor	Image Sensor	ON Semiconductor	SONY
	Max. Image Resolution	1920H x 1200V	2560H x 1920V
	Max. Frame Rate	100fps(1920×1080)	30fps(2560×1920)
	WDR	Digital WDR	HDR
	Day/Night Mode	Day/Night/Auto	Day/Night/Auto
Lens	Effective Focal Length	3.5~9.85mm	3mm
	Field of View	Wide: D128.1°×H103.1°×V60.6 Tele: D39.9°×H33.8°×V21.1°	D140.7°×H107°×V77.8°
	Focus Control	Oneshot auto focus/ Manual focus	Fixed M12 Lens
	Aperture	F1.8~F3.3	F2.0
	Iris Control	Auto	Fixed type

Mechanical

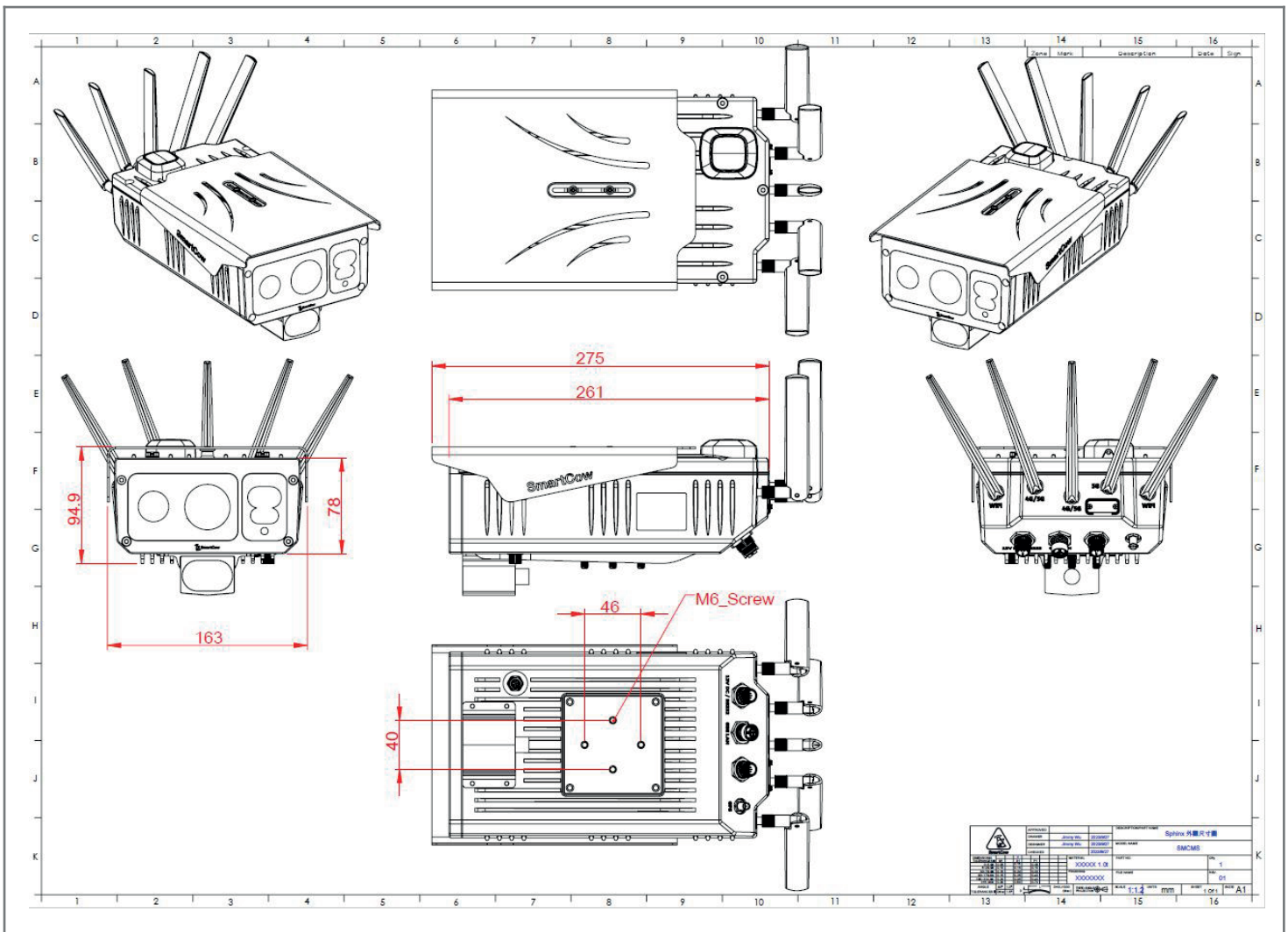

Ordering Information

Model Name	Description
SMCMS-XN08	Sphinx w/ Xavier NX 8G, 128G NVME SSD, 12V DC in, 60W adapter, -20~50°C
SMCMS-XN16	Sphinx w/ Xavier NX 16G, 128G NVME SSD, 12V DC in, 60W adapter, -20~50°C
SMCMS-RN08	Sphinx w/ Orin NX 8G, 128G NVME SSD, 12V DC in, 60W adapter, -20~50°C
SMCMS-RN16	Sphinx w/ Orin NX 16G, 128G NVME SSD, 12V DC in, 60W adapter, -20~50°C

Packing List

Item	Description	Qty
SmartCam	The Sphinx main unit	1
Adapter	12V 5A, 60W	1
Power cord	US, EU or UK version	1
M12 (12pin) cable	For power and RS232	1
M12 (8pin) cable	For Ethernet	1
Wall mount	Camera bracket	1

Accessories (Optional)

Part Number	Description
1Y0701800200LI	US Power Cord
1Y0701800100LI	EU Power Cord
51-U00000000003	M.2 B-key 3042 LTE module: QUECTEL EM06ELA-512-SGAS LTE Antennas *2pcs
61-ULT00001RQU	M.2 B-key 3052 5G module: QUECTEL RM502Q-AE 5G Antennas *3pcs GPS Antenna *1pc
61-UWF000000IT	M.2 E-key 2230 WIFI module: Intel® Wireless-AC 9260, Wi-Fi 5 (802.11ac), BT5.1 WiFi Antennas *2pcs
TBD	UPS RS232 cables
TBD	LiDAR
TBD	Weather sensor
TBD	3-axis mount